

URBANTIME



DIEMMEB SINCE 1983 [®]
COMMUNITY HOME URBANTIME

URBANTIME

Urban spaces, large public areas and shopping centres have become integral parts of our living habits: more and more time is spent in these places, Hence the idea of turning them into a domestic environment, as comfortable as possible, where social life can develop in full comfort.

This idea has led to designing the first collection for street furniture and large areas by Diemmebi, a leading company on the international markets for the production of furniture for public spaces. This collection, named URBANTIME, has been designed by Alberto Basaglia and Natalia Rota Nodari.

There are two product ranges: Zeroquindici.015 and Ventiquattrore.h24.

The first one, completely made of metal, is characterized by a simple round pipe which can be bent and coupled in several ways, thus taking different shapes and allowing countless compositions.

The second range made of steel and aluminium staves also suggests new types of use, such as with the flat double seat with backrest.

Both product ranges are designed for outdoor use, however they do not disdain indoor spaces such as shopping centres, large covered surfaces, lounges, airports, railway stations, bus stations.

As for all products made by the Company, special attention is devoted to the environment: both ranges are completely recyclable and feature special materials that require less maintenance.

Gli spazi urbani, le grandi aree pubbliche e commerciali sono diventate parti integranti delle nostre case; il tempo speso in questi luoghi diventa sempre piu' lungo, quindi perché non trasformarli in un ambiente il più possibile accogliente e domestico, dove la vita sociale possa scorrere in pieno comfort.

Da questa idea nasce la prima collezione per l'arredo urbano e i grandi spazi di Diemmebi, azienda riconosciuta a livello internazionale per la produzione di arredi da comunità, denominata URBANTIME e progettata da Alberto Basaglia e Natalia Rota Nodari.

Due sono le linee di prodotti: Zeroquindici.015 e Ventiquattrore.h24.

La prima si distingue per l'utilizzo di un semplice tubo tondo che, diversamente calandrato e accoppiato, assume molteplici forme, permettendo infinite composizioni.

La seconda invece, composta da una struttura in acciaio e doghe in alluminio, fa il verso alle classiche panchine in metallo e legno, proponendo nel contempo nuove tipologie di utilizzo come nel caso della panca piana con schienale e doppia seduta.

Pensate entrambe per un uso esterno sia pubblico che domestico, non disdegnano gli spazi interni come centri commerciali, grandi aree coperte, sale d'attesa, aeroporti, stazioni ferroviarie e stazioni di autobus.

Un'attenzione particolare è riservata, come peraltro per tutta le produzioni dell' Azienda, all'ambiente: entrambe le linee sono completamente riciclabili e per la particolarità dei materiali prescelti non necessitano di manutenzione frequente.

DIEMMEBI[®]
COMMUNITY HOME URBANTIME







TOP FOUR BLACK
Design Alberto Basaglia, Natalia Pola Noceri

TOP FOUR YELLOW
Design Alberto Basaglia, Natalia Pola Noceri

TOP FOUR BLUE
Design Alberto Basaglia, Natalia Pola Noceri





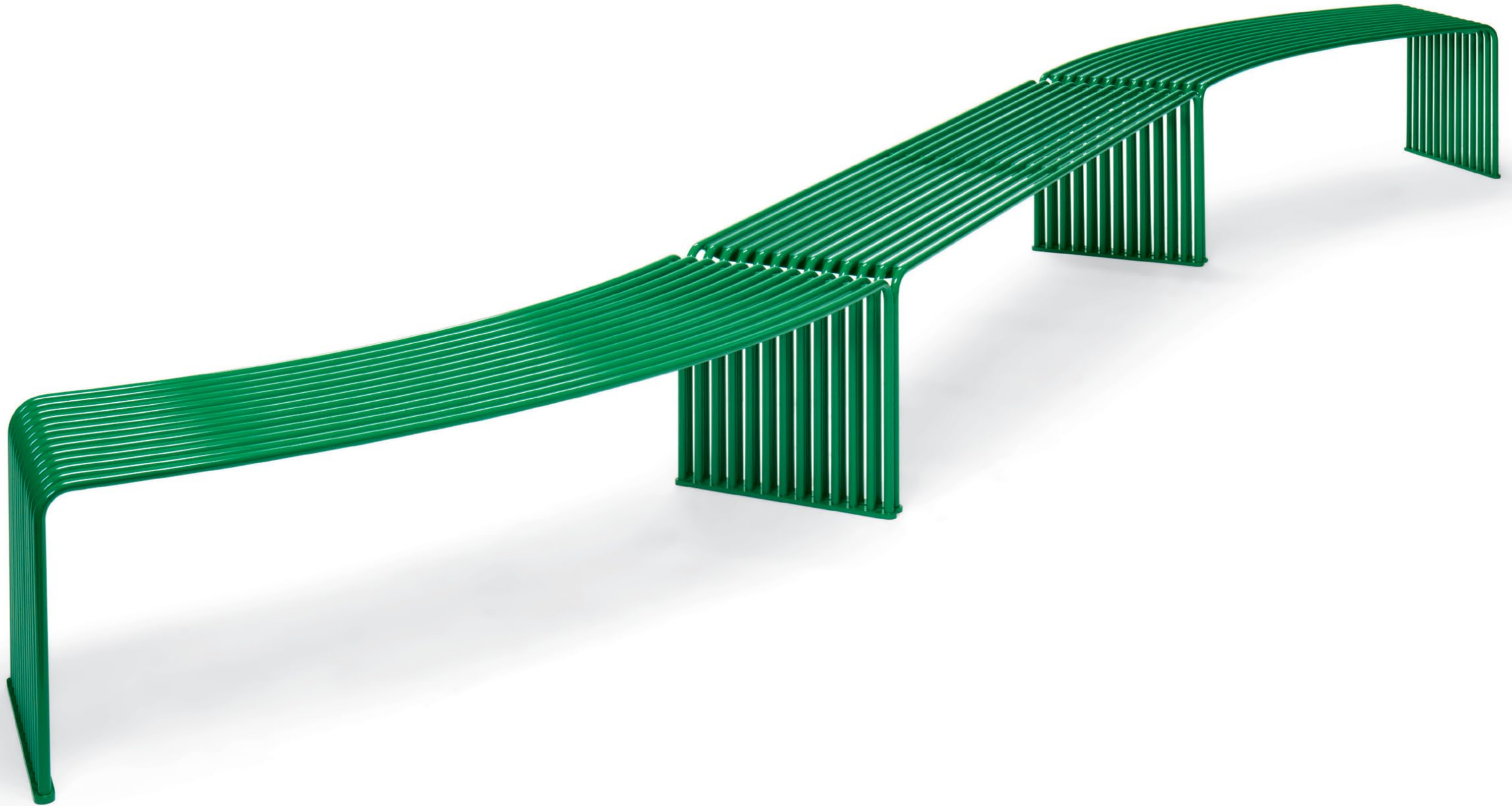



ZEROQUINDICI.015 PANCA CON SCHIENALE - SEAT WITH BACKREST









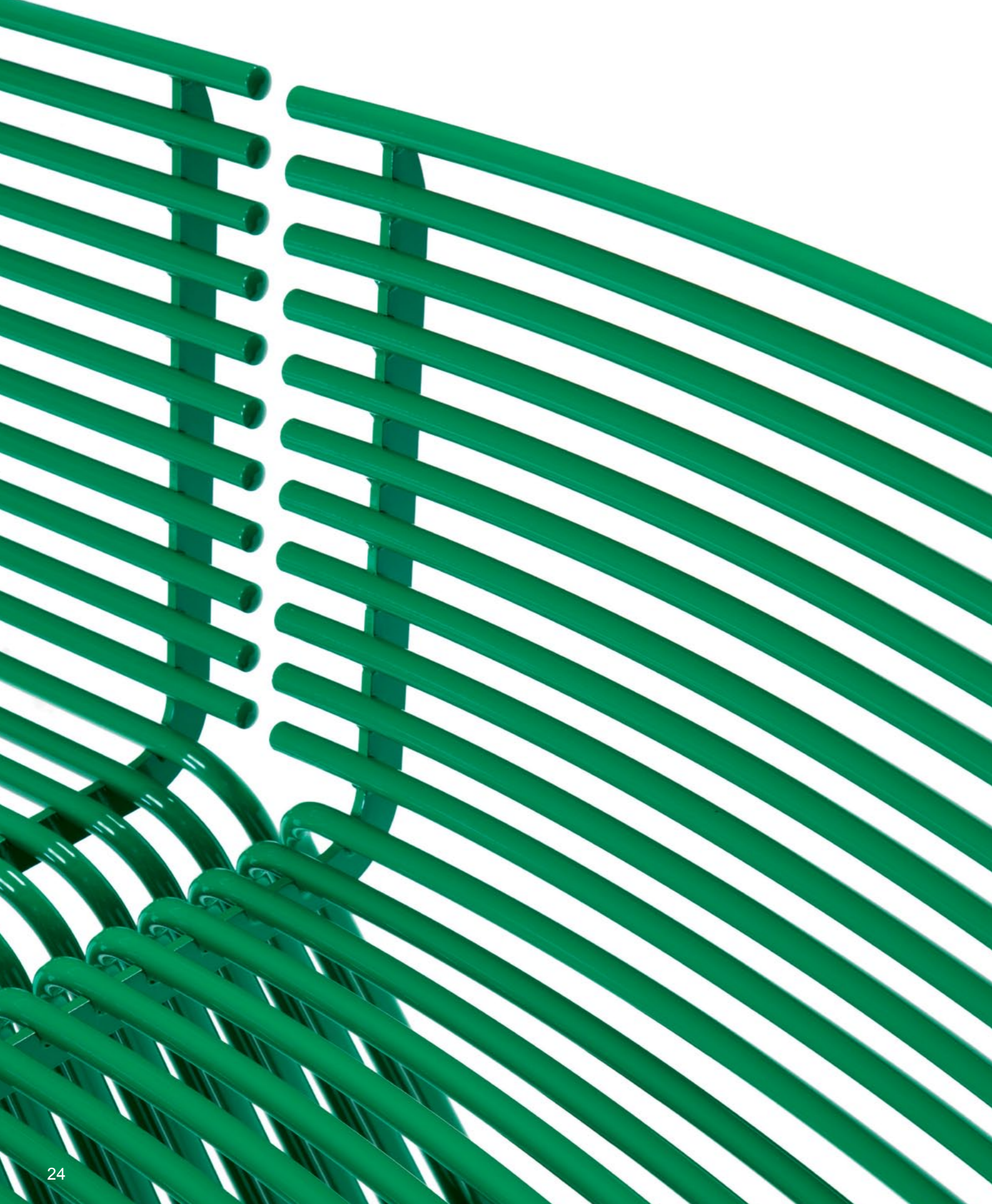





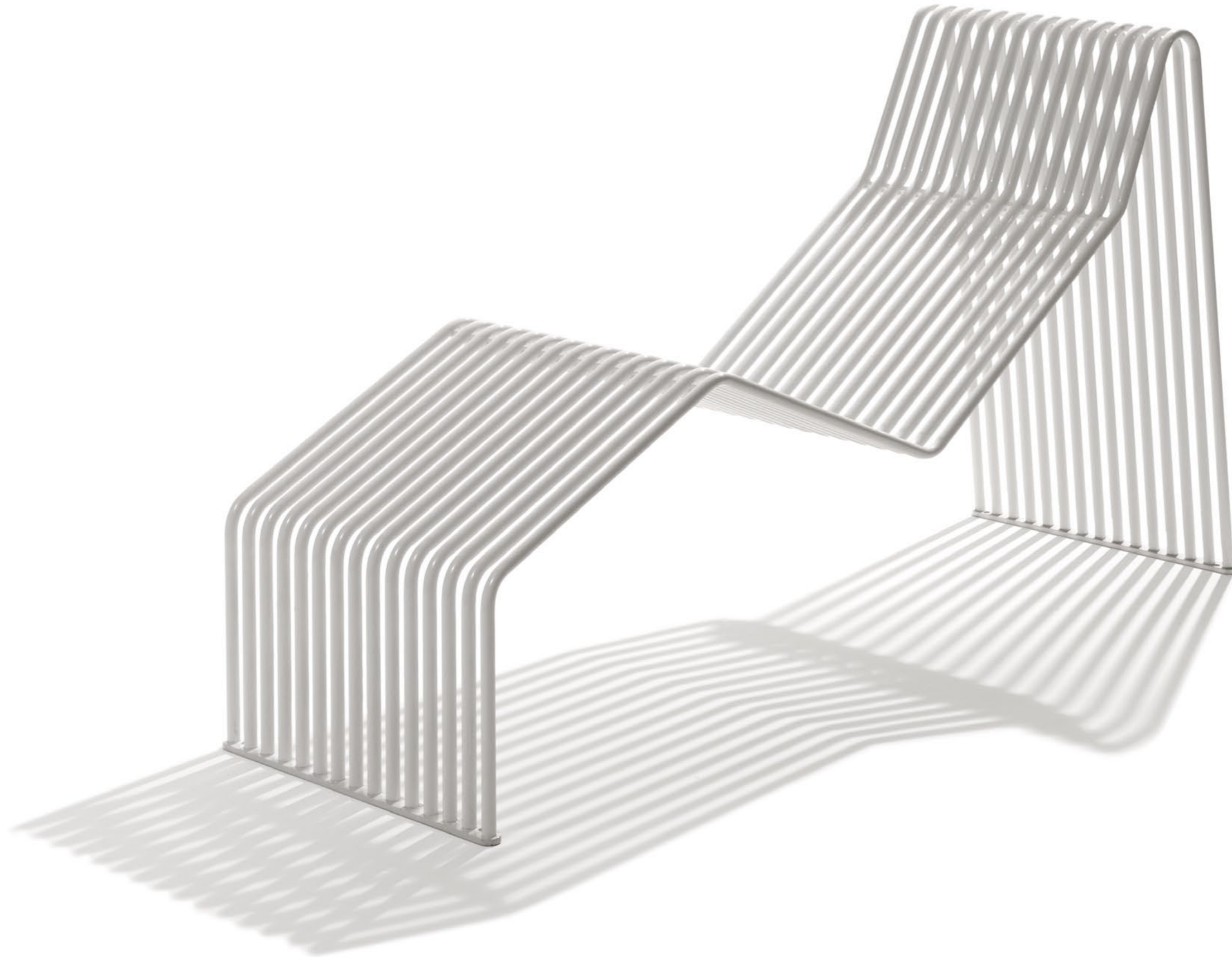



ZEROQUINDICI.015 SOFA

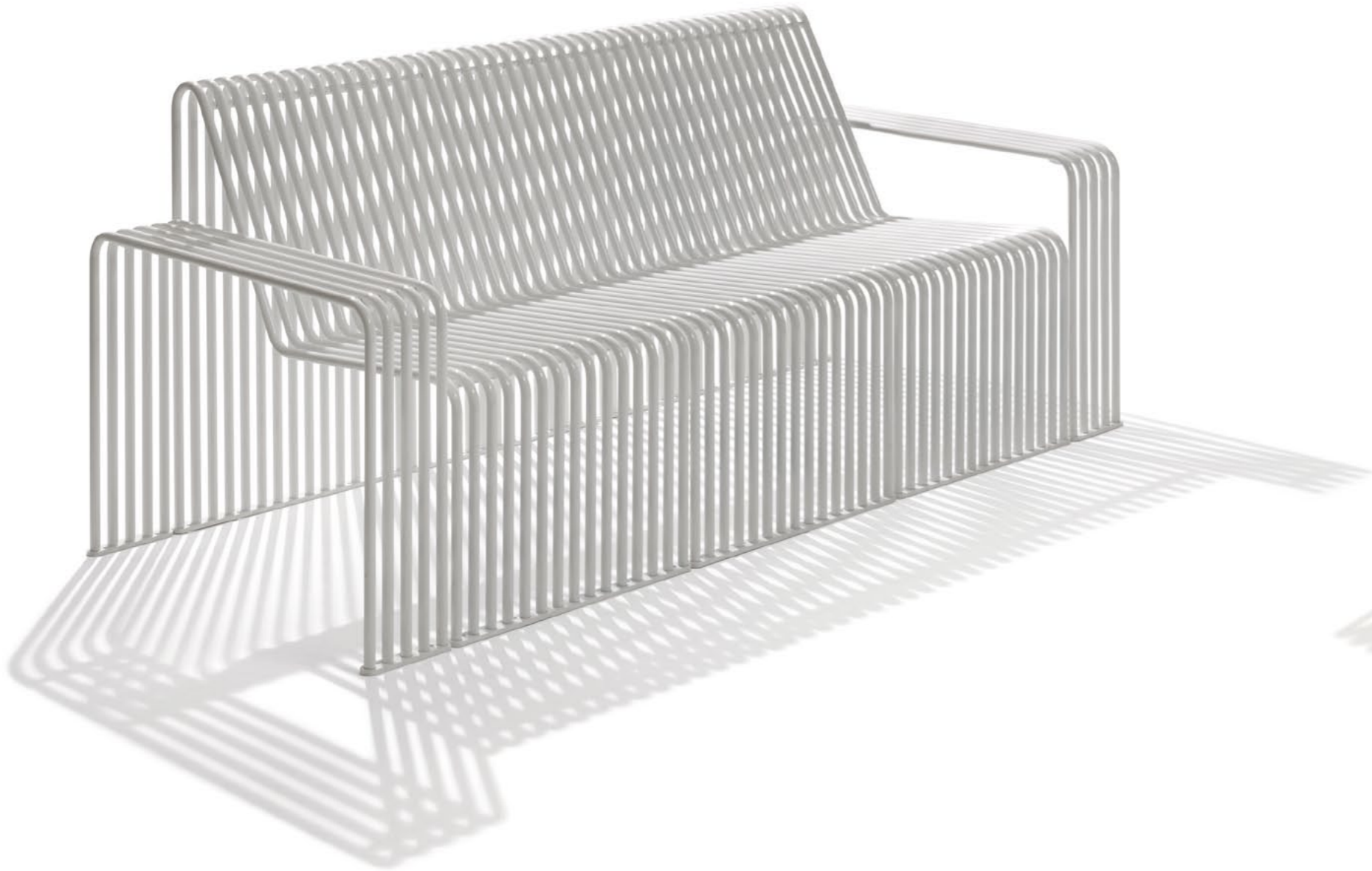

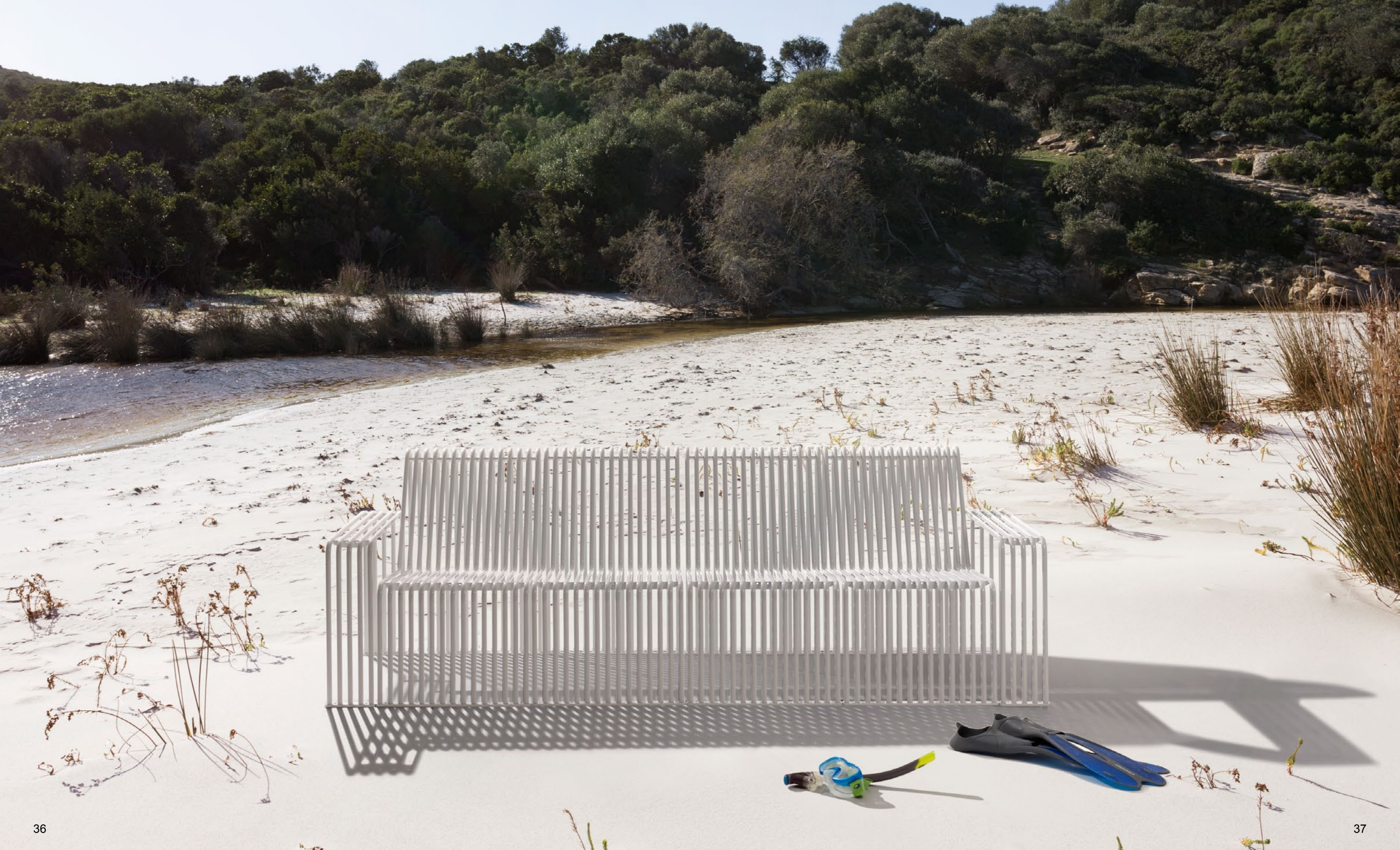

















ZEROQUINDICI.015

Design Alberto Basaglia Natalia Rota Nodari

Famiglia di sedute: panca piana, panca piana concava-convessa, panca con schienale, panca con schienale concava, panca con schienale convessa, chaise longue, tavolo, barbecue e divano modulare. Struttura in tubi calandrati di diametro 18 mm, in acciaio inox o acciaio verniciato con polveri epossidiche in diversi colori. La struttura in metallo per uso esterno viene sottoposta a trattamento di zincatura a caldo. Predisposta per il fissaggio a terra con tasselli o per l'aggancio multiplo con piastra in acciaio.

Family of seats: flat bench, flat bench concave or convex, seat with backrest, concave seat with backrest, convex seat with backrest, chaise longue, table, barbecue and modular sofa. Bent pipe structure, diameter 18mm, made of stainless steel or epoxy powder coated steel tube available in different colours. Hot-dip galvanized steel for outdoor use version. Ready-equipped for fastening to the ground with bolts or steel linking plate.

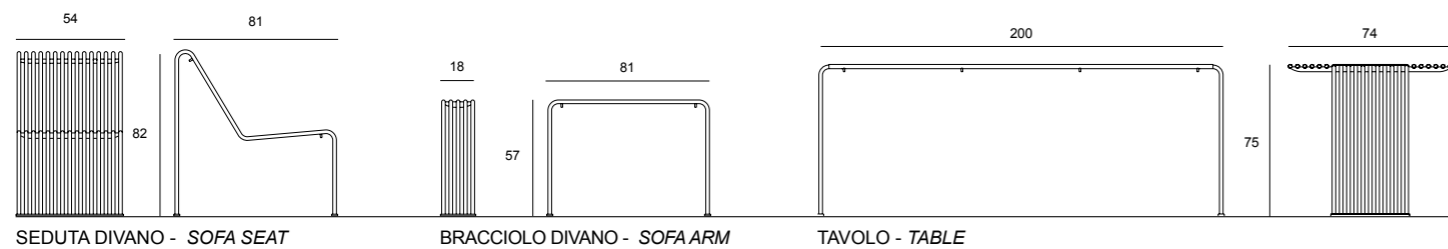
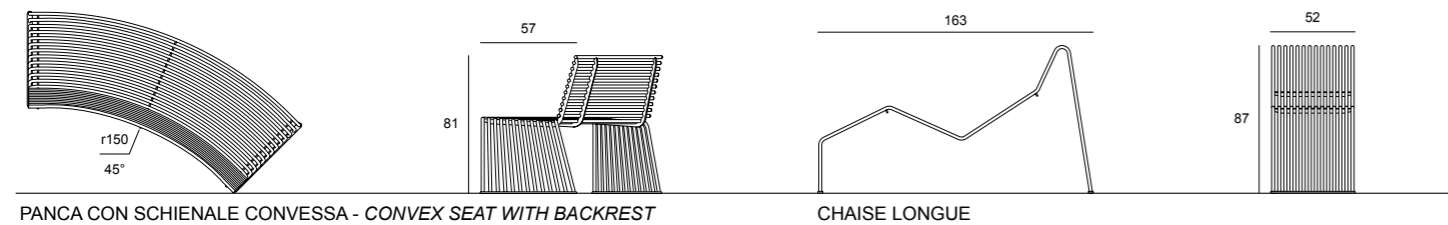
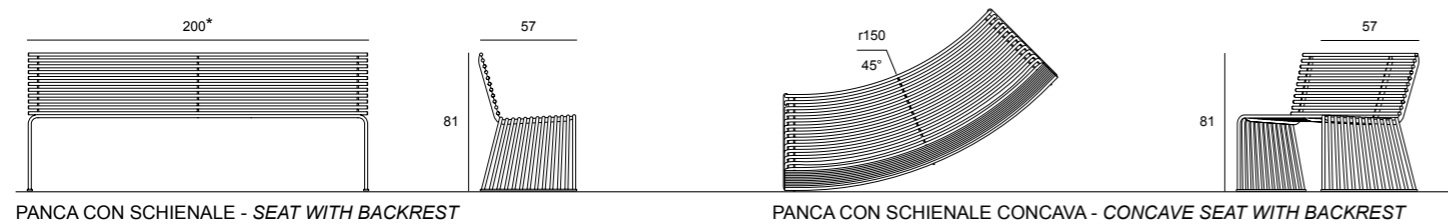
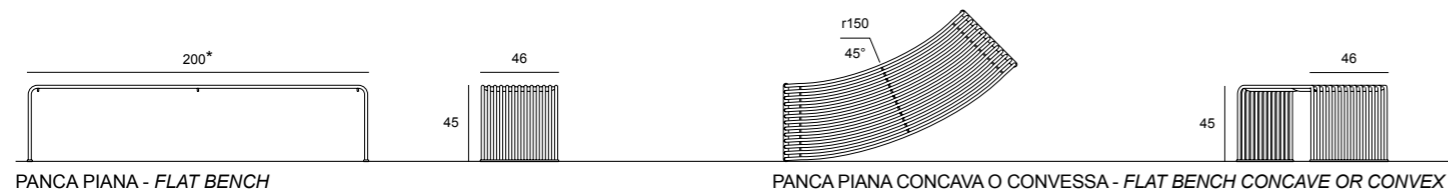

Alcune finiture presentate sono illustrative e disponibili solo su richiesta

*su misura / *on request

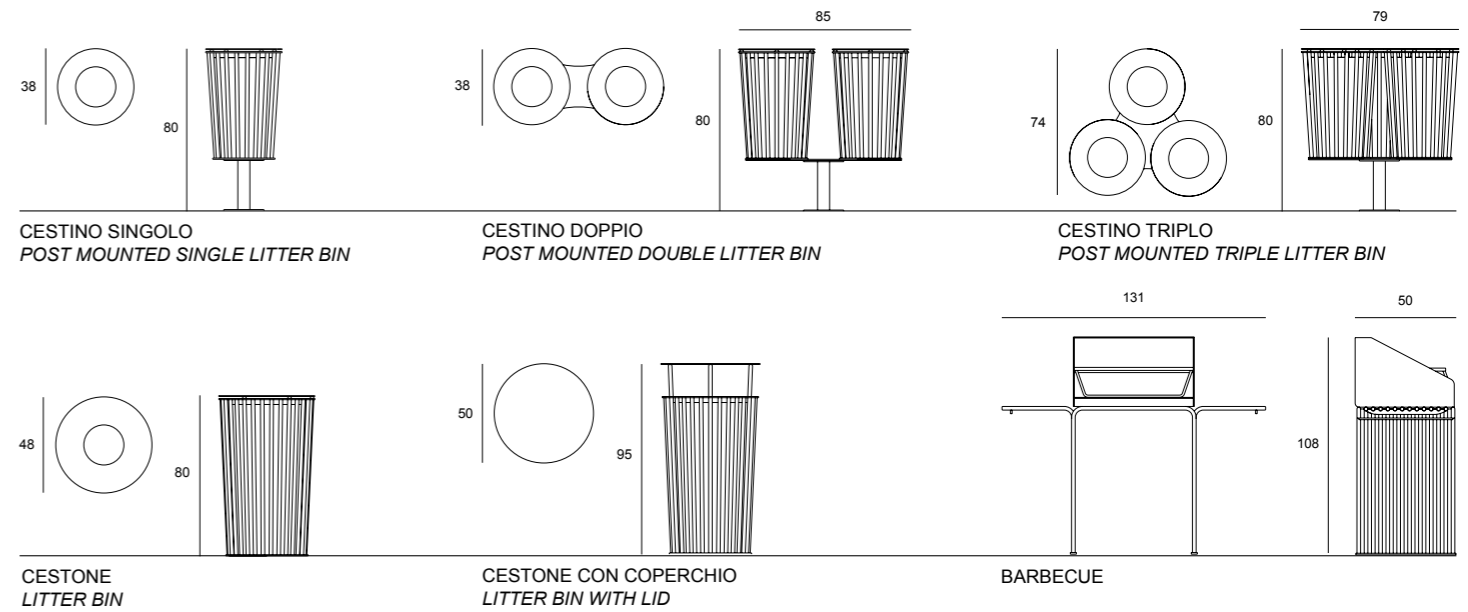

VENTIQUATTRORE.h24

Design Alberto Basaglia Natalia Rota Nodari

Famiglia di sedute e tavolo: panca piana, panca con schienale, panca con schienale e doppia seduta, tavolo. Struttura in acciaio verniciato con polveri epossidiche in diversi colori. La struttura in metallo per uso esterno viene sottoposta a trattamento di zincatura a caldo. Seduta in doghe di alluminio verniciate con polveri epossidiche di diversi colori oppure decorate frassino naturale con film sublimatico. Predisposta per il fissaggio a terra con tasselli.

Family of seats and table: flat bench, seat with backrest, double seat with backrest, table. Structure made of steel, epoxy painted in different colours. Hot-dip galvanized steel for outdoor use version. Seat made of aluminium staves, epoxy painted in different colours or decorated with heat transfer film for a natural ash wood grain effect. Ready-equipped for fastening to the ground with bolts.

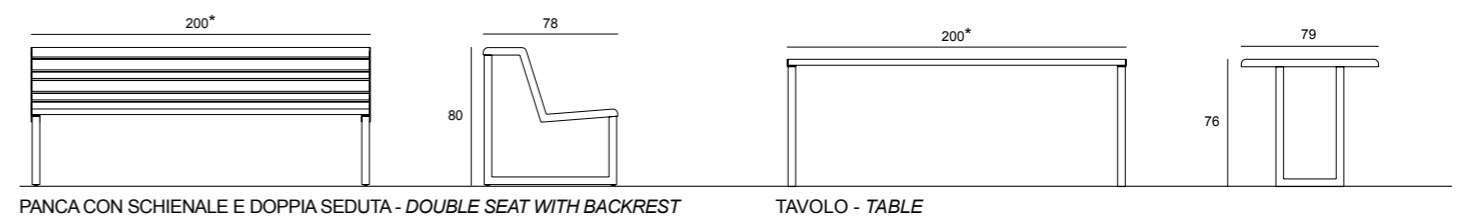
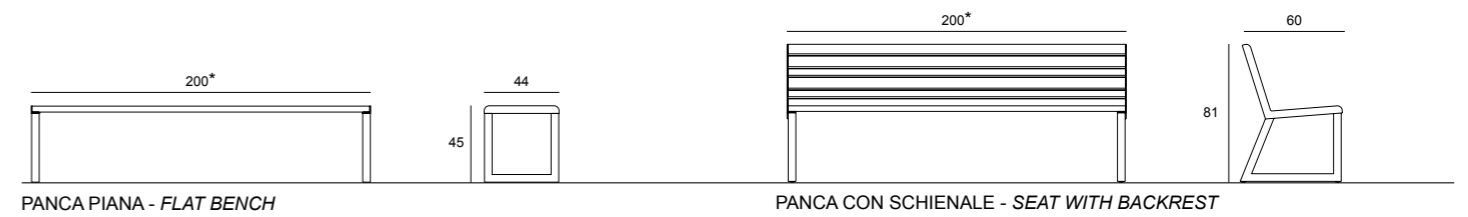

Some of the finishes shown are for illustration purposes and are available only on request.

*su misura / *on request

Art Director:
Alberto Basaglia

Concept and Graphic designer:
Alberto Basaglia Natalia Rota Nodari Architetti Associati

Photo:
Corrado Maria Crisciani
Carlos & Dario Tettamanzi

Print:
CPZ

Diemmebi si riserva il diritto di apportare eventuali modifiche
di parti o dettagli ritenuti necessari.
Modelli e marchi depositati.

*Diemmebi has the right to change at any time
the parts or details it deems necessary.
Registered models and trademarks.*

DIEMMEB[®]
COMMUNITY HOME URBAN TIME

Diemmebi SpA • Via dell'Industria 14 • 31029 Vittorio Veneto (TV) • Italy
TEL. +39 0438 912433 • Fax +39 0438 500392 • info@diemmebi.com • www.diemmebi.com
Registro Imprese TV, Partita IVA e C.F. 01664230263 • REA TV 161319 • Cap. Sociale € 250.000,00 i.v.